

SPICE thermal model

PSMN4R0-60YS

Symbol	Parameter	Conditions	Min	Typ	Max	Unit
$R_{th(j-mb)}$	thermal resistance from junction to mounting base		-	-	0.50	K/W

C_{th1}	2.939E-04 F
C_{th2}	1.562E-04 F
C_{th3}	1.060E-03 F
C_{th4}	2.029E-03 F
C_{th5}	1.136E-02 F
C_{th6}	3.191E-02 F
C_{th7}	8.830E-01 F
R_{th1}	4.313E-04 Ω
R_{th2}	6.433E-03 Ω
R_{th3}	1.069E-02 Ω
R_{th4}	4.452E-02 Ω
R_{th5}	9.438E-02 Ω
R_{th6}	2.626E-01 Ω
R_{th7}	8.098E-02 Ω

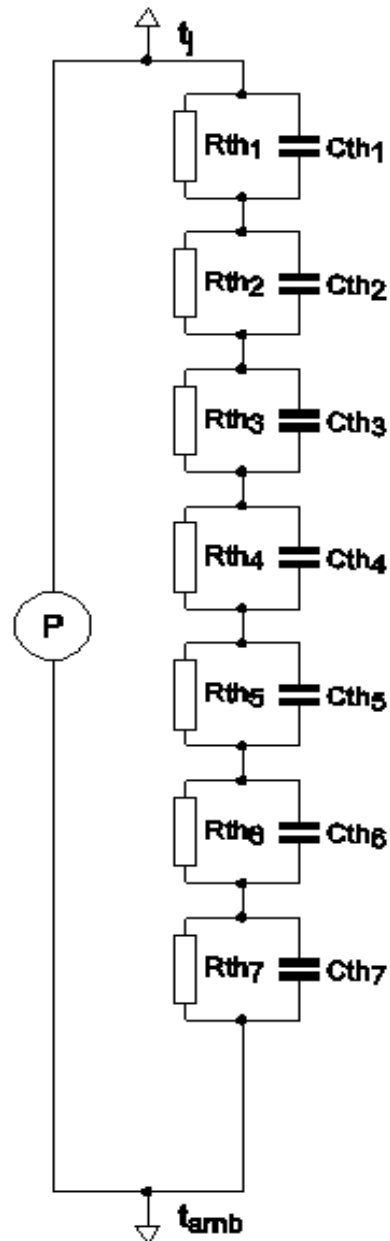

Part: PSMN4R0-60YS
 Date: 6/7/2015
 Model Rth 0.50 K/W